

BAV70TT1

Preferred Device

Dual Switching Diode

Features

- Pb-Free Package May be Available.* The G-Suffix Denotes a Pb-Free Lead Finish

MAXIMUM RATINGS ($T_A = 25^\circ\text{C}$)

Rating	Symbol	Max	Unit
Reverse Voltage	V_R	70	Vdc
Forward Current	I_F	200	mAdc
Peak Forward Surge Current	$I_{FM}(\text{surge})$	500	mAdc

THERMAL CHARACTERISTICS

Characteristic	Symbol	Max	Unit
Total Device Dissipation, FR-4 Board (1) $T_A = 25^\circ\text{C}$ Derated above 25°C	P_D	225	mW
Thermal Resistance, Junction to Ambient (1)	$R_{\theta JA}$	555	$^\circ\text{C}/\text{W}$
Total Device Dissipation, FR-4 Board (2) $T_A = 25^\circ\text{C}$ Derated above 25°C	P_D	360	mW
Thermal Resistance, Junction-to-Ambient (2)	$R_{\theta JA}$	345	$^\circ\text{C}/\text{W}$
Junction and Storage Temperature Range	T_J, T_{stg}	-55 to +150	$^\circ\text{C}$

- FR-4 @ Minimum Pad
- FR-4 @ 1.0×1.0 Inch Pad



ON Semiconductor®

<http://onsemi.com>

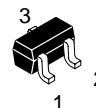
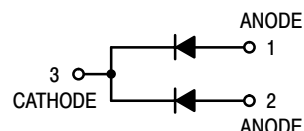

CASE 463
SOT-416/SC-75
STYLE 3

DEVICE MARKING

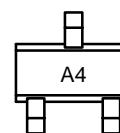

ORDERING INFORMATION

Device	Package	Shipping†
BAV70TT1	SOT-416	3000 / Tape & Reel
BAV70TT1G	SOT-416 (Pb-Free)	3000 / Tape & Reel

†For information on tape and reel specifications, including part orientation and tape sizes, please refer to our Tape and Reel Packaging Specifications Brochure, BRD8011/D.

*For additional information on our Pb-Free strategy and soldering details, please download the ON Semiconductor Soldering and Mounting Techniques Reference Manual, SOLDERM/D.

Preferred devices are recommended choices for future use and best overall value.

BAV70TT1

ELECTRICAL CHARACTERISTICS (T_A = 25°C unless otherwise noted)

Characteristic	Symbol	Min	Max	Unit
OFF CHARACTERISTICS				
Reverse Breakdown Voltage (I _(BR) = 100 μAdc)	V _(BR)	70	–	Vdc
Reverse Voltage Leakage Current (Note 3) (V _R = 70 Vdc) (V _R = 50 Vdc)	I _R I _R	– –	5.0 100	μAdc nAdc
Diode Capacitance (V _R = 0, f = 1.0 MHz)	C _D	–	1.5	pF
Forward Voltage (I _F = 1.0 mAdc) (I _F = 10 mAdc) (I _F = 50 mAdc) (I _F = 150 mAdc)	V _F	– – – –	715 855 1000 1250	mVdc
Reverse Recovery Time (I _F = I _R = 10 mAdc, R _L = 100 Ω, I _{R(REC)} = 1.0 mAdc) (Figure 1)	t _{rr}	–	6.0	ns
Forward Recovery Voltage (I _F = 10 mAdc, t _r = 20 ns) (Figure 2)	V _{RF}	–	1.75	V

3. For each individual diode while the second diode is unbiased.

BAV70TT1

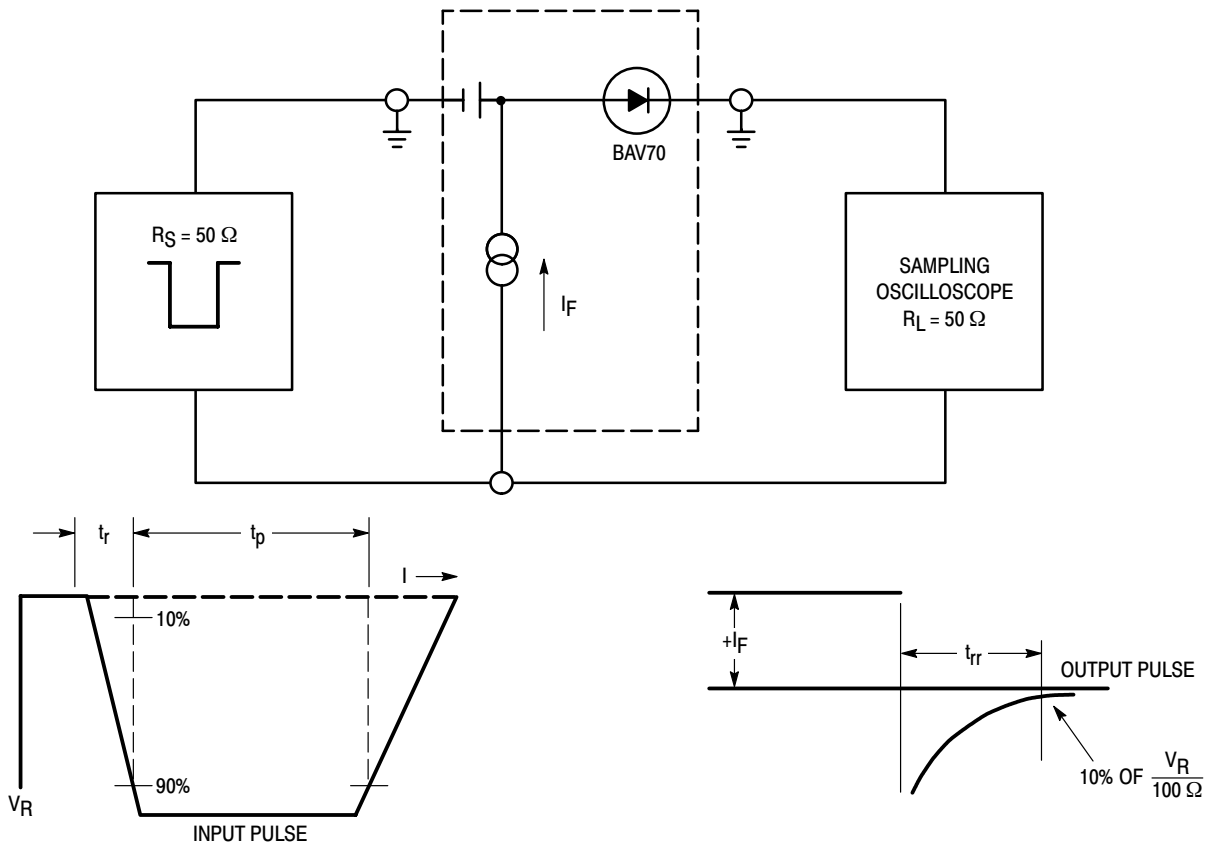

Figure 1. Recovery Time Equivalent Test Circuit

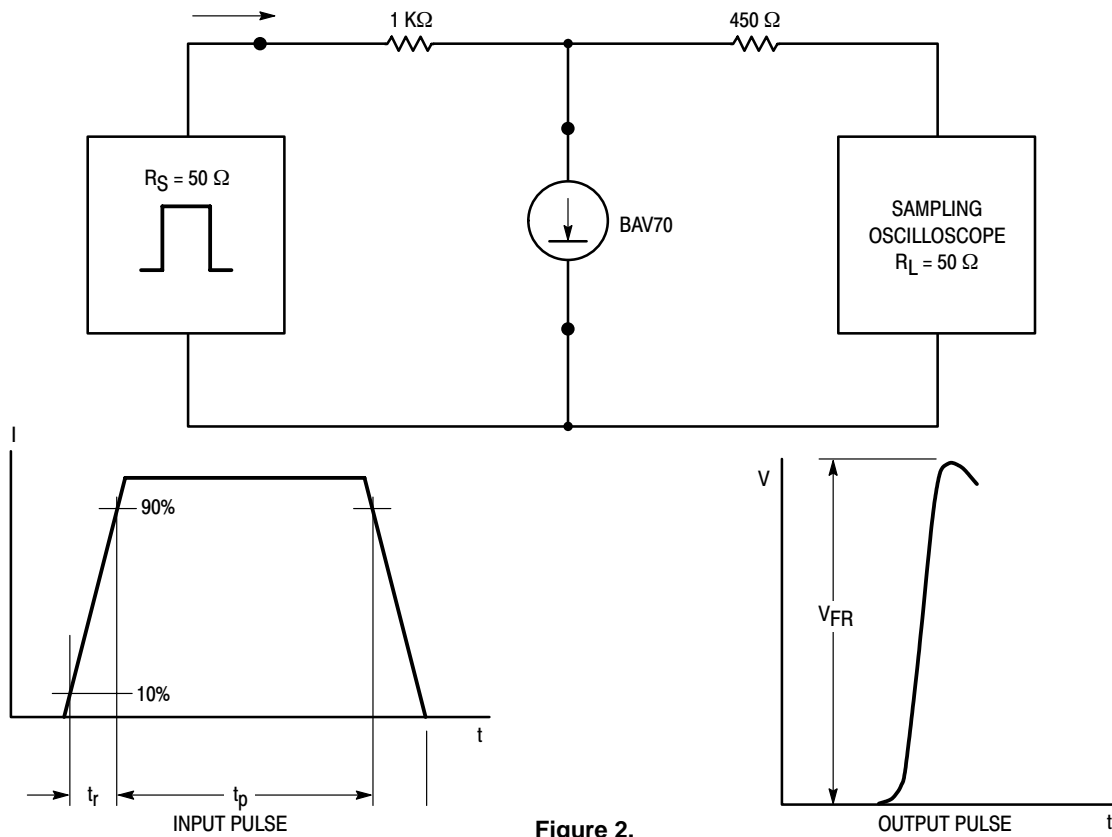

Figure 2.

BAV70TT1

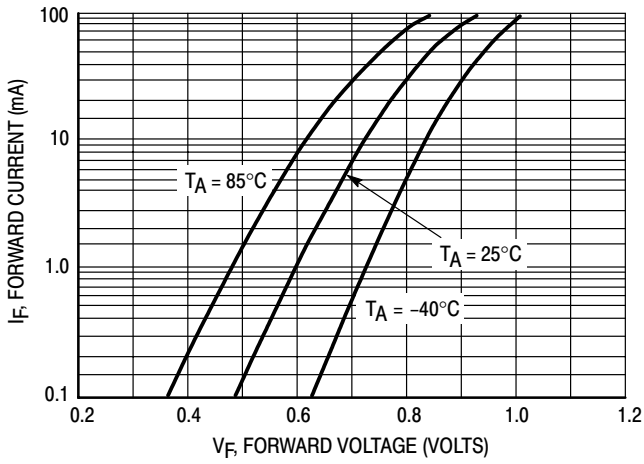

Figure 3. Forward Voltage

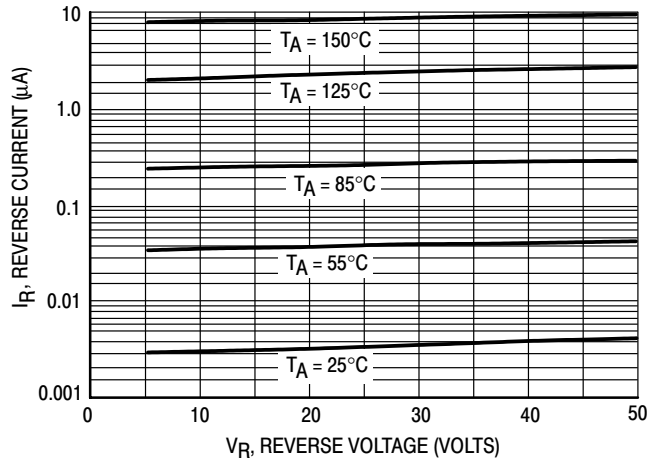

Figure 4. Leakage Current

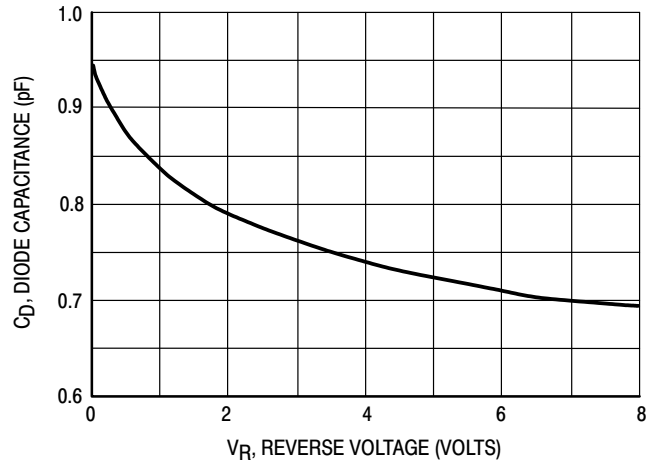

Figure 5. Capacitance

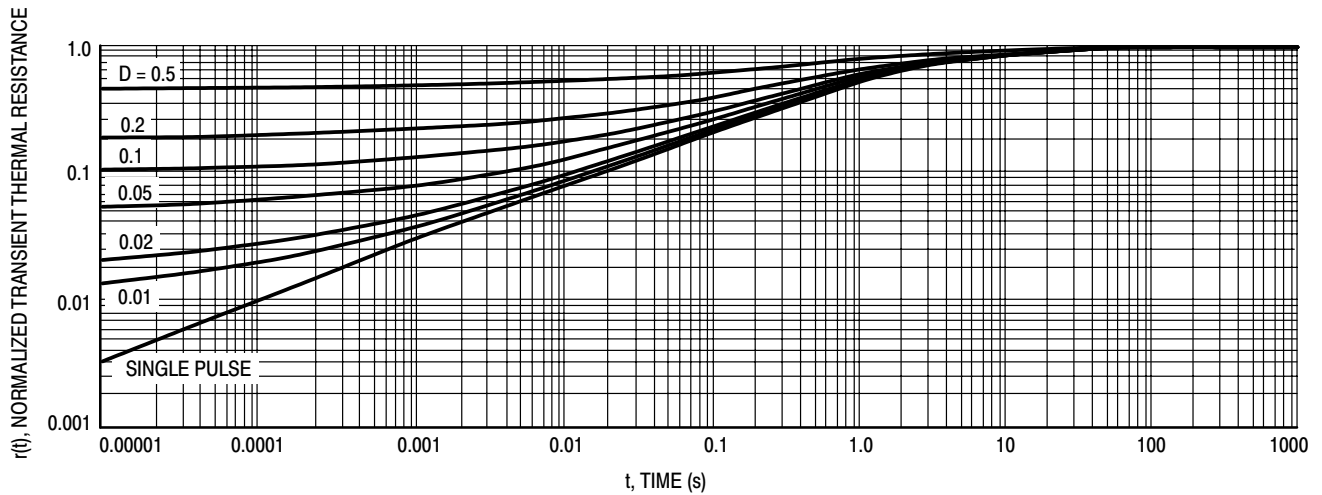
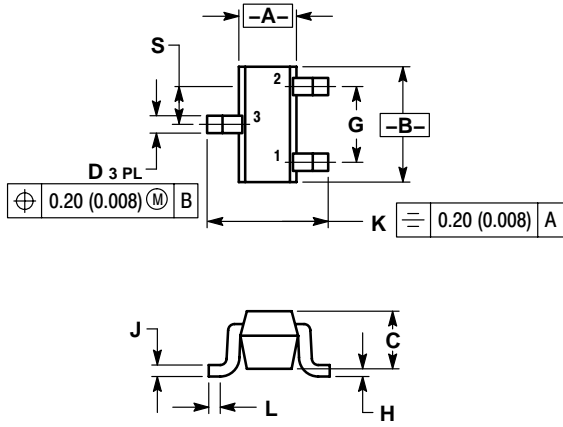

Figure 6. Normalized Thermal Response

BAV70TT1

PACKAGE DIMENSIONS

SC-75 (SC-90, SOT-416)
CASE 463-01
ISSUE C



NOTES:

1. DIMENSIONING AND TOLERANCING PER ANSI Y14.5M, 1982.
2. CONTROLLING DIMENSION: MILLIMETER.

DIM	MILLIMETERS		INCHES	
	MIN	MAX	MIN	MAX
A	0.70	0.90	0.028	0.035
B	1.40	1.80	0.055	0.071
C	0.60	0.90	0.024	0.035
D	0.15	0.30	0.006	0.012
G	1.00 BSC		0.039 BSC	
H	---	0.10	---	0.004
J	0.10	0.25	0.004	0.010
K	1.45	1.75	0.057	0.069
L	0.10	0.20	0.004	0.008
S	0.50 BSC		0.020 BSC	

STYLE 3:

- PIN 1. ANODE
- ANODE
- CATHODE

BAV70TT1

ON Semiconductor and  are registered trademarks of Semiconductor Components Industries, LLC (SCILLC). SCILLC reserves the right to make changes without further notice to any products herein. SCILLC makes no warranty, representation or guarantee regarding the suitability of its products for any particular purpose, nor does SCILLC assume any liability arising out of the application or use of any product or circuit, and specifically disclaims any and all liability, including without limitation special, consequential or incidental damages. "Typical" parameters which may be provided in SCILLC data sheets and/or specifications can and do vary in different applications and actual performance may vary over time. All operating parameters, including "Typicals" must be validated for each customer application by customer's technical experts. SCILLC does not convey any license under its patent rights nor the rights of others. SCILLC products are not designed, intended, or authorized for use as components in systems intended for surgical implant into the body, or other applications intended to support or sustain life, or for any other application in which the failure of the SCILLC product could create a situation where personal injury or death may occur. Should Buyer purchase or use SCILLC products for any such unintended or unauthorized application, Buyer shall indemnify and hold SCILLC and its officers, employees, subsidiaries, affiliates, and distributors harmless against all claims, costs, damages, and expenses, and reasonable attorney fees arising out of, directly or indirectly, any claim of personal injury or death associated with such unintended or unauthorized use, even if such claim alleges that SCILLC was negligent regarding the design or manufacture of the part. SCILLC is an Equal Opportunity/Affirmative Action Employer. This literature is subject to all applicable copyright laws and is not for resale in any manner.

PUBLICATION ORDERING INFORMATION

LITERATURE FULFILLMENT:

Literature Distribution Center for ON Semiconductor
P.O. Box 5163, Denver, Colorado 80217 USA

Phone: 303-675-2175 or 800-344-3860 Toll Free USA/Canada

Fax: 303-675-2176 or 800-344-3867 Toll Free USA/Canada

Email: orderlit@onsemi.com

N. American Technical Support: 800-282-9855 Toll Free
USA/Canada

Japan: ON Semiconductor, Japan Customer Focus Center
2-9-1 Kamimeguro, Meguro-ku, Tokyo, Japan 153-0051
Phone: 81-3-5773-3850

ON Semiconductor Website: <http://onsemi.com>

Order Literature: <http://www.onsemi.com/litorder>

For additional information, please contact your
local Sales Representative.